

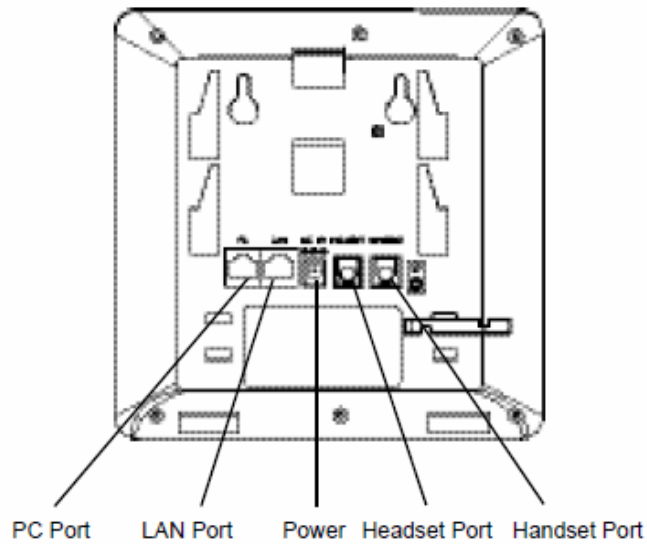

**GXP1450 2-Line IP Phone**

---

**CONNECTING THE PHONE:**



**Keypad Layout**

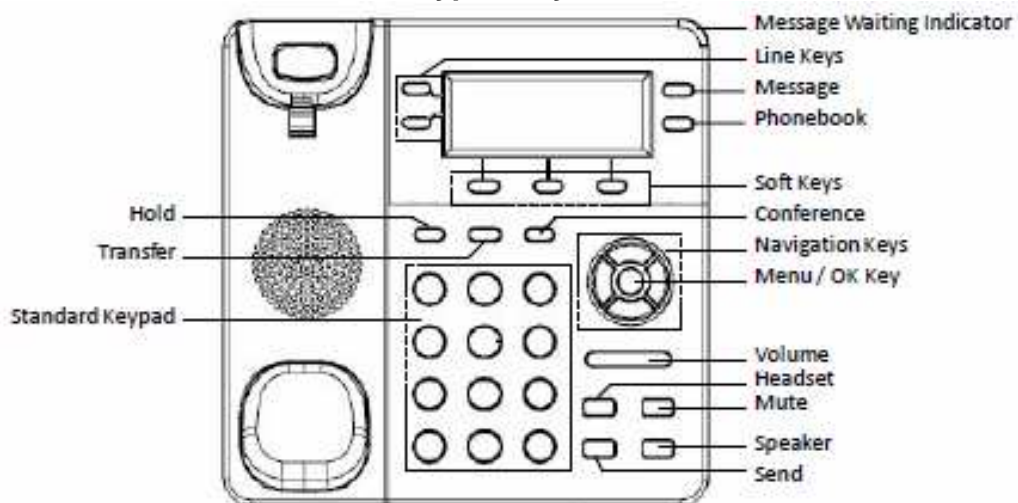



**GXP2100 4-Line IP Phone**

---

**Connections**

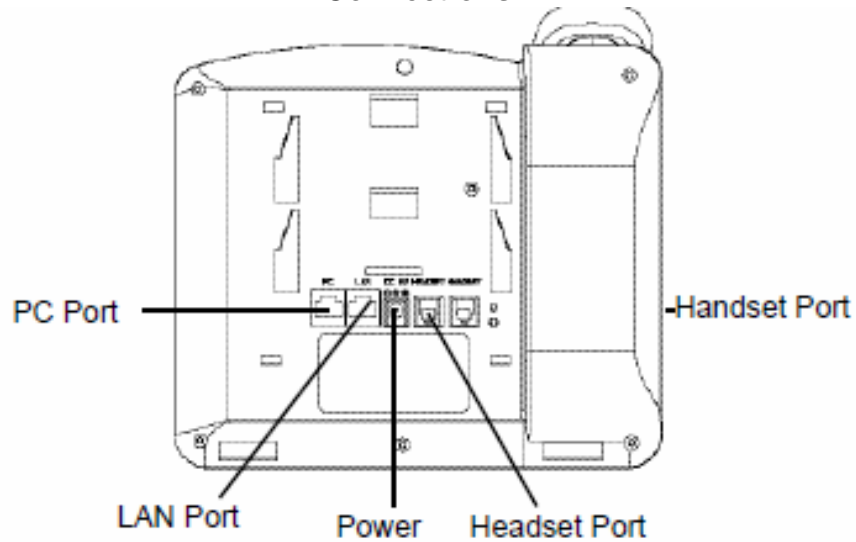

**Keypad Layout**

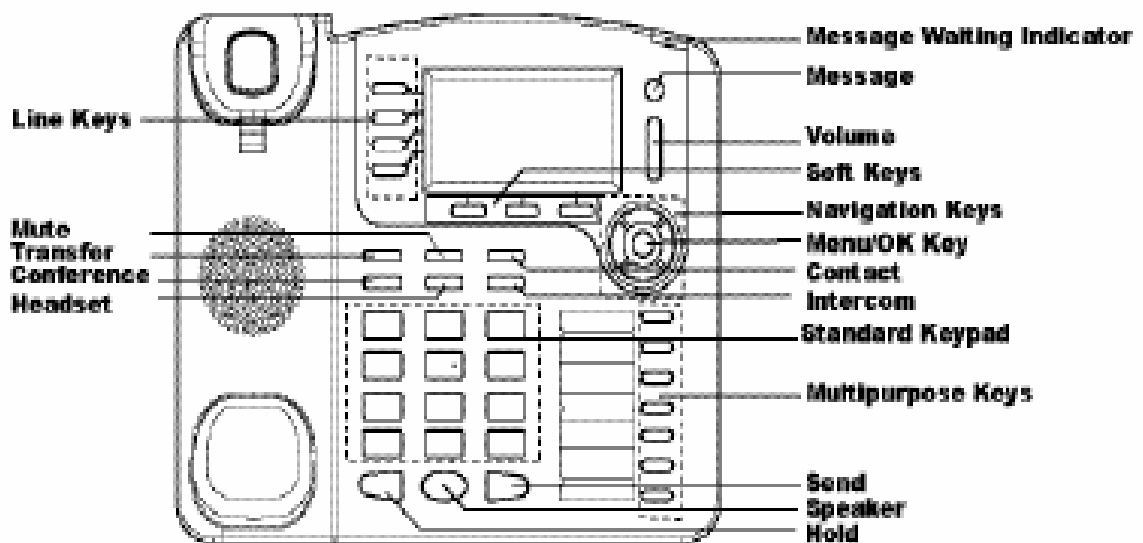



**GXP2110 4-Line IP Phone**

---

**Connections**

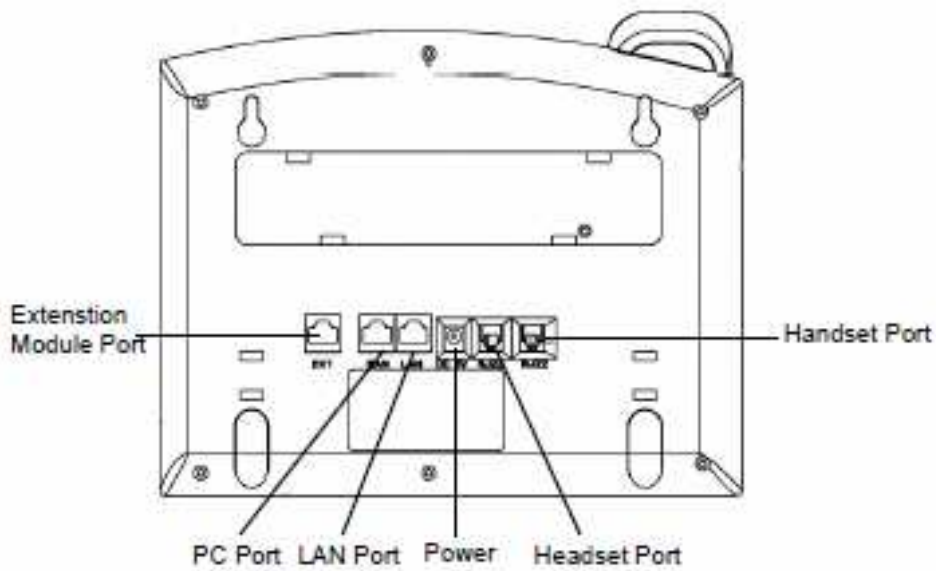

**Keypad Layout**

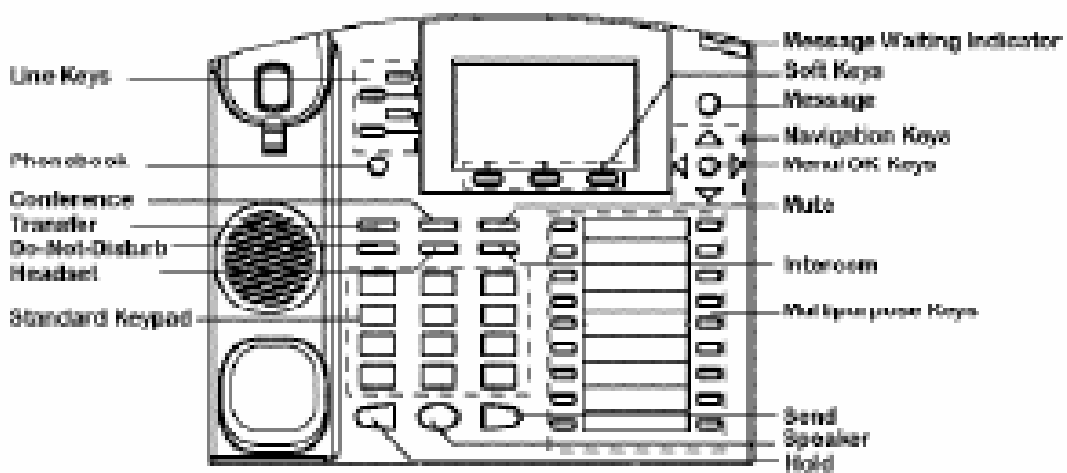



**GXP2120 6-Line IP Phone**

---

**Connections**

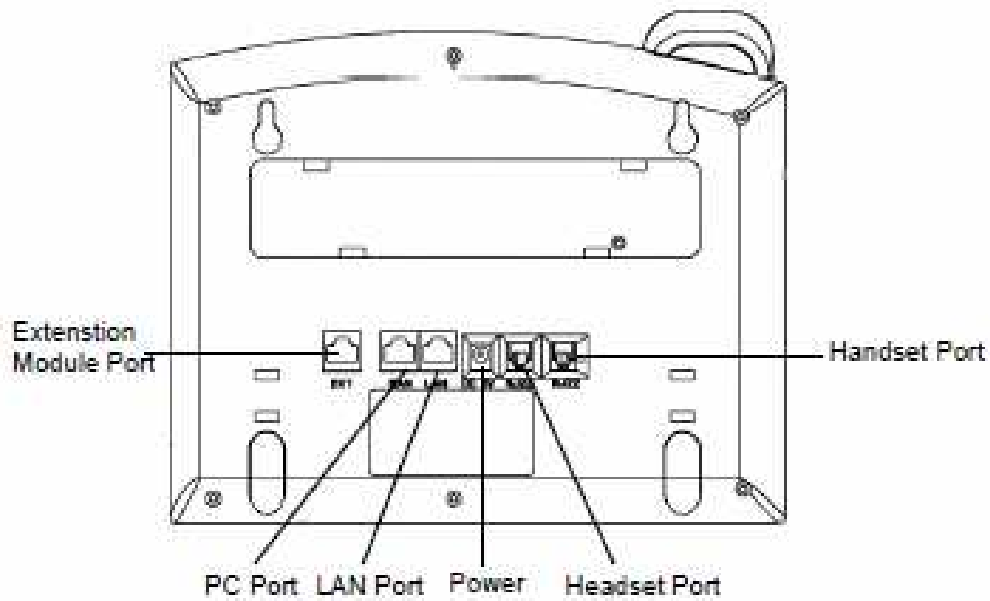

**Keypad Layout**

